

**Data Sheet | Item Number: 221-612**

Conector COMPACT; pentru toate tipurile de conductori; max. 6 mm<sup>2</sup>; 2 conductori;  
cu levieri; carcasă transparentă; Temperatură aer ambiant: max 85°C (T85); 6,00  
mm<sup>2</sup>; transparent



<https://www.wago.com/221-612>



Color:  transparent

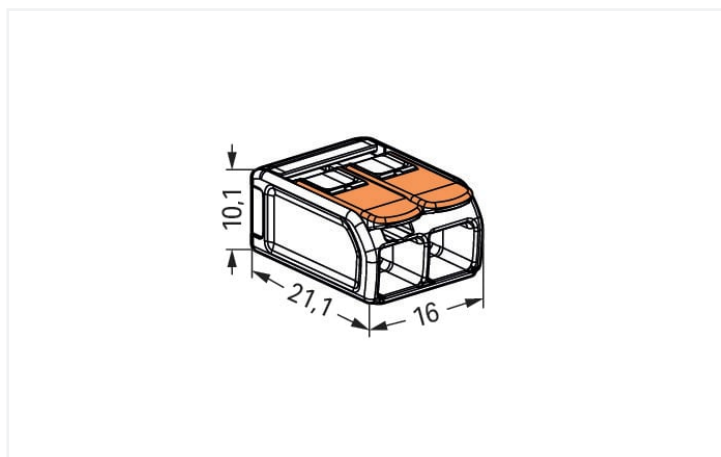

Dimensions in mm

## Your benefits:

- Ease of use – pull the lever up, insert a conductor and push the lever back down
- Available as 2-, 3- and 5-wire connectors
- Easily terminate conductors from 0.5 to 6 mm<sup>2</sup>
- Connection of all conductor types
- Time savings for installers and device manufacturers
- Quickly install devices with higher power consumption
- Safely install long cable runs with larger conductor cross sections
- Mounting carrier for installation conforms to standards
- Custom carriers are possible

## Notes

Safety information	in grounded power lines
--------------------	-------------------------

## Electrical data

Ratings per	EN 60664		
Overvoltage category	III	III	II
Pollution degree	3	2	2
Nominal voltage	-	-	450 V
Rated surge voltage	-	-	4 kV
Rated current	-	-	41 A

Approvals per	UL 486C		
Use group	B	C	D
Rated voltage	-	600 V	-
Rated current	-	30 A	-

## Connection data

Connection points	2
Total number of potentials	1

Connection 1	
Connection technology	CAGE CLAMP®
Actuation type	Lever
Connectable conductor materials	Copper
Nominal cross-section	6 mm <sup>2</sup> / 10 AWG
Solid conductor	0,5 ... 6 mm <sup>2</sup> / 20 ... 10 AWG
Stranded conductor	0,5 ... 6 mm <sup>2</sup> / 20 ... 10 AWG
Fine-stranded conductor	0,5 ... 6 mm <sup>2</sup> / 20 ... 10 AWG
Strip length	12 ... 14 mm / 0.47 ... 0.55 inci
Wiring direction	Side-entry wiring

## Physical data

Width	16 mm / 0.63 inci
Height	10,1 mm / 0.398 inci
Depth	21,1 mm / 0.831 inci

## Material data

Note (material data)	<a href="#">Information on material specifications can be found here</a>
Color	transparent
Cover color	transparent
Insulation material	Polycarbonate (PC)
Flammability class per UL94	V2
Fire load	0.05 MJ
Actuator color	orange
Weight	3 g

### Environmental requirements

Ambient temperature (operation)	+85 °C
Continuous operating temperature	105 °C
Temperature marking per EN 60998	T85

### Commercial data

eCl@ss 10.0	27-14-11-04
eCl@ss 9.0	27-14-11-04
ETIM 8.0	EC000446
ETIM 7.0	EC000446
PU (SPU)	500 (50) Buc.
Packaging type	Box
Country of origin	CH
GTIN	4055143704168
Customs tariff number	85369010000

### Environmental Product Compliance

RoHS Compliance Status	Compliant, No Exemption
------------------------	-------------------------

### Approvals / Certificates

#### General approvals



Approval	Standard	Certificate Name
CB DEKRA Certification B.V.	IEC 60998	NL-81003
cULus_Listed_667F Underwriters Laboratories Inc.	UL 486C	UL-CA-L69654
ENEC 05 DEKRA Certification B.V.	EN 60998	71-123784
UL_Listed_64KA UL International Germany GmbH	UL 467	E201573

#### Declarations of conformity and manufacturer's declarations

Approval	Standard	Certificate Name
EU-Declaration of Conformity WAGO GmbH & Co. KG	-	-
UK-Declaration of Conformity WAGO GmbH & Co. KG	-	-

### Approvals for marine applications



Approval	Standard	Certificate Name
ABS American Bureau of Shipping	EN 60998	18-HG1755093-PDA
DNV GL Det Norske Veritas, Germanischer Lloyd	EN 60998	TAE000015T
LR Lloyds Register	EN 60998	LR22207029TA

### Downloads

#### Documentation

Bid Text			
221-612	19.02.2019	xml 3.47 KB	
221-612	23.01.2019	docx 15.62 KB	
ausschreiben.de 221-612			

## CAD/CAE-Data

CAD data	CAE data
2D/3D Models 221-612	EPLAN Data Portal 221-612
	ZUKEN Portal 221-612

## 1 Compatible Products

### 1.1 Optional Accessories

#### 1.1.1 General accessories

##### 1.1.1.1 Moisture protection



###### Item No.: 207-1431

Gelbox; Derivație; pentru cabluri; cu gel; Seria 221; conectori de max. 6 mm<sup>2</sup>; fără conectori pentru cutia de joncțiune; Mărima 1; gri



###### Item No.: 207-1432

Gelbox; Derivație; pentru cabluri; cu gel; Seria 221; conectori de max. 6 mm<sup>2</sup>; fără conectori pentru cutia de joncțiune; Mărima 2; gri



###### Item No.: 207-1433

Gelbox; Derivație; pentru cabluri; cu gel; Seria 221; conectori de max. 6 mm<sup>2</sup>; fără conectori pentru cutia de joncțiune; Mărima 3; gri

#### 1.1.2 Jumper

##### 1.1.2.1 Jumper



###### Item No.: 221-941/000-006

Șunt; pentru intrare conductor; 2 căi; izolat; albastru



###### Item No.: 221-942/000-006

Șunt; pentru intrare conductor; 2 căi; izolat; albastru



###### Item No.: 221-941

Șunt; pentru intrare conductor; 2 căi; izolat; gri închis



###### Item No.: 221-942

Șunt; pentru intrare conductor; 2 căi; izolat; gri închis

#### 1.1.3 Mounting adapter

##### 1.1.3.1 Mounting accessories



###### Item No.: 221-510/000-006

Suport de montaj; Seria 221 - 6 mm<sup>2</sup>; pt mont. pe șină DIN 35/montare cu șurub; albastru



###### Item No.: 221-510/000-053

Suport de montaj; Seria 221 - 6 mm<sup>2</sup>; pt mont. pe șină DIN 35/montare cu șurub; gri-galben închis



###### Item No.: 221-510

Suport de montaj; Seria 221 - 6 mm<sup>2</sup>; pt mont. pe șină DIN 35/montare cu șurub; portocaliu

## Installation Notes

### Conductor termination

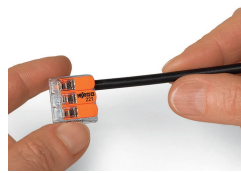
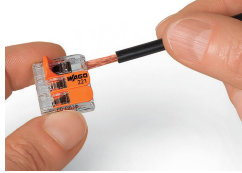
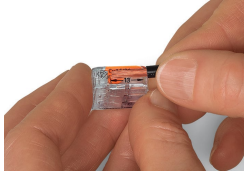

Strip conductor to 12 ... 14 mm.

Termination: Lift the lever to open the clamping unit and insert a stripped conductor.

Then, lower the lever to close the clamp.

### Application

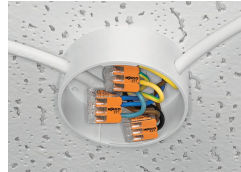
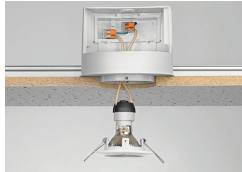
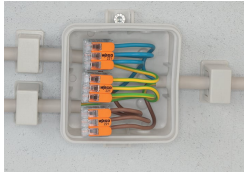

Wiring fine-stranded conductors in junction boxes.

Custom low-voltage lighting system

Lighting distribution in a ceiling canopy

Pendant light connection in a suspended ceiling



COMPACT Splicing Connectors for All Conductor Types (6 mm<sup>2</sup>), 221 Series