

M12 female 90° A-cod. IDC3-pol., 0.25 - 0.5mm², 4 - 5,1mm

Female 90°

M12, 3-pole

IDC terminals

Connection cross section: 0.25...0.5 mm²

Art-No. 7005 - M12 Lite - (plastic hexagonal screw) on request

The resistance to aggressive media should be individually tested for your application. Further details on request.

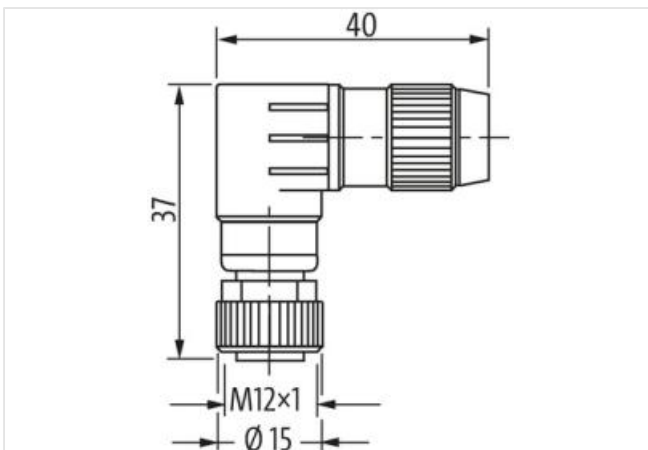
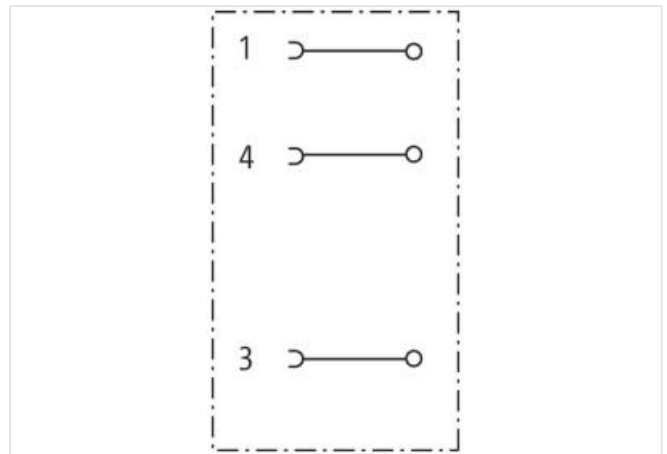
[Link to Product](#)**Illustration**

Product may differ from Image

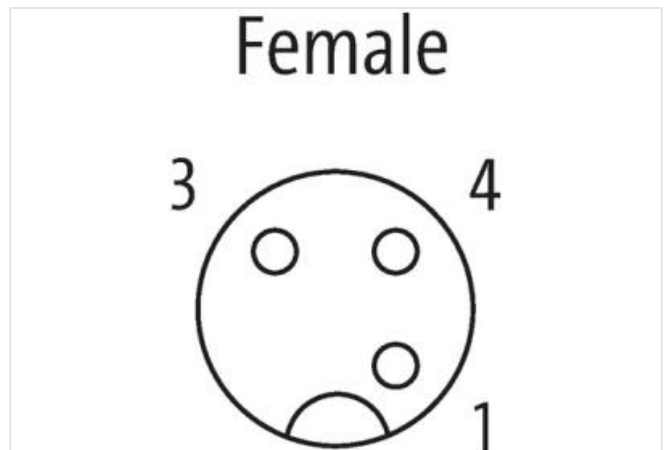
**Side 1**

Family form head 1	M12
Degree of protection (EN IEC 60529)	IP67

Commercial data

ECLASS-6.0	27279221
ECLASS-6.1	27260702
ECLASS-7.0	27440102
ECLASS-8.0	27440102
ECLASS-9.0	27440116

ECLASS-10.1	27440102
ECLASS-11.1	27440102
ECLASS-12.0	27440116
ETIM-5.0	EC002635
customs tariff number	85366990
GTIN	4048879201704
Packaging unit	1

Electrical data | Supply

Operating voltage AC max.	32 V
Operating voltage DC max.	32 V
Current operating per contact max.	4 A

Installation

Connection cross section min.	0,25 mm ²
Connection cross section max.	0,5 mm ²
Single wire diameter min.	0,1 mm

Installation | Connection

Wire insulation diameter min.	1,2 mm
Wire insulation diameter max.	1,6 mm
Tightening torque	0,6 Nm

Device protection | Electrical

Protection degree additional condition	inserted, screwed
--	-------------------

Mechanical data | Mounting data

Mounting method	inserted, screwed, Shaking protection
Clamping range min.	4 mm
Clamping range max.	5,1 mm
Height	37 mm
Width	40 mm
Depth	15 mm

Environmental characteristics | Climatic

Operating temperature min.	-25 °C
Operating temperature max.	85 °C