

Emparro Power Supply 3-PHASE

IN: 360 - 500VAC OUT: 24-28V/10ADC

INPUT: 3 × 324...572 V AC / 450...745 V DC

OUTPUT: 24...28 V DC

Current: 10 A

[Link to Product](#)

Illustration

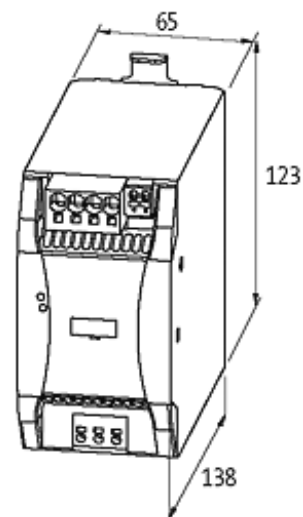

Product may differ from Image

Approvals



Input	
Input voltage	3 × 324...572 V AC/450...745 V DC
Input current	0.75 A (3 × 360 V AC); 0.45 A (3 × 500 V AC)
Inrush current after 1 ms	max. 9 A
Power factor	0.66 (3 × 500 V AC)
Frequency	50...60 Hz
Input fuse (internal)	3 × 6.3 A (T)
General data	
Standards	EN 60950-1, EN 61204-3, EN 55011 B, EN 61000-3-2, SEMI F47
Relative humidity	5...95 %, no condensation
Efficiency	93.7 % (3 × 400 V AC); 93.2 % (3 × 480 V AC)
Dimensions H × W × D	143×65×143 mm
Mounting method	DIN-rail mountable TH35 (EN 60715)
Temperature range	-40...+70 °C, ...+70 °C derating (storage temperature -40...+85 °C)
Output	
Output voltage	24 V DC (SELV), ±1 %; 24...28 V adjustable
Power Boost	lout N × 150 % (min. 5 s)
Output current	12 A (45 °C); 10 A (60 °C); 7 A (70 °C)
Mains failure bridging time	min. 45 ms (3 × 500 V AC); 10 A (24 V DC)
Ripple	max. 20 mVrms
Spikes	max. 50 mV p-p
Unit protection	short circuit and overload protected, permanently by 20 % (to 45 °C)
LED display	LED (green): OK; LED (red): overload, overheating or short-circuit
Parallel usage/serial usage	max. 3 units
Commercial data	
country of origin	CH
customs tariff number	85044090
minimum order quantity	1